

**Product**

- Purist® Tall single lever basin mixer

**Kohler Code**

14404A-4AND-\*

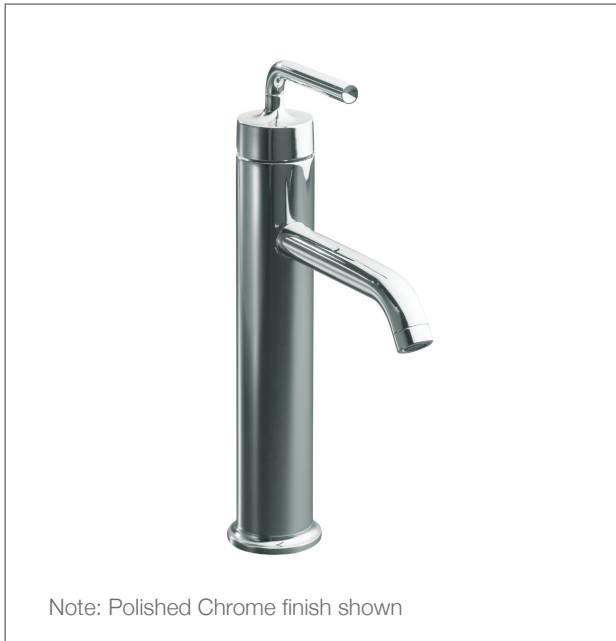

**Included Components**

- Braided stainless steel hoses





**Features**

- Choice of 5 colours
- Metal construction
- Ceramic disc cartridge
- Suitable for mains pressure
- KOHLER finishes resist tarnishing and corrosion



WELS RATING  
(5 Star 6.0 Litres / min)

**PVD Colour Options** (Colour swatches indicative only)

-  14404A-4AND-CP - Polished Chrome
-  14404A-4AND-BV - Vibrant Brushed Bronze
-  14404A-4AND-BN - Vibrant Brushed Nickel
-  14404A-4AND-PGD - Vibrant Moderne Polished Gold
-  14404A-4AND-RGD - Vibrant Rose Gold

**Related Products**

- Purist accessories
- Purist tapware

**Technical Details**

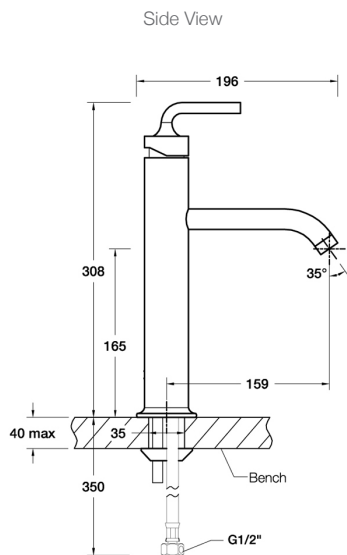

G1/2" is equal to BSP1/2"

**Installation Notes:**

- Optimum working pressure 300-500 kPa.
- Maximum hydrostatic pressure 800 kPa (This pressure may be exceeded only under test conditions).
- Maximum temperature 80°C.
- Maximum bench thickness is 40mm.
- Where normal working pressure exceeds the maximum, pressure limiting valves should be installed.
- Inline filters should be used to protect tapware from debris that may be present within the plumbing.