

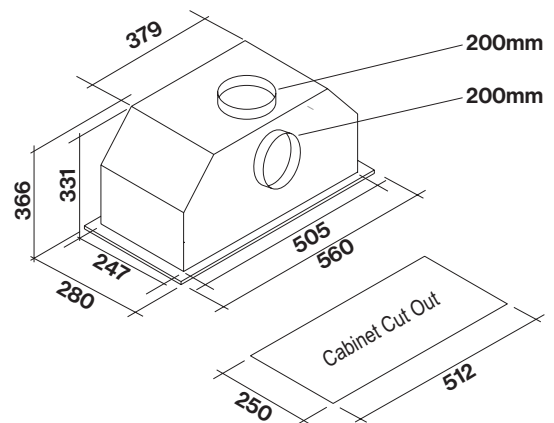

Product Features

Motor Type	Off Board Motor
Dimensions	560 x 280 x 363mm Suits 50cm-75cm cooking surfaces
Filtration Type	Baffle Filters x 2
Lighting	Adaptive Dynamic LED Strip
Finish	Surgical grade 304 stainless steel
Frame	Flushmount
Controls	Slim profile touch control (optional remote controller)
Speed Settings	3 speed + Boost
Timer Function	15 min Auto Shut-Off
Ducting	200mm Circular Outlet + 5m of flexible ducting supplied
Installation Info	Quick Install Clips
Other	N/A

Dimensioned Drawings



Model Code	Motor Output	Motor Solution
FP3ML60S2-IR765	765m ³ /hr	In Roof Motor
FP3ML60S2-ER765	765m ³ /hr	External Roof Motor
FP3ML60S2-EW765	765m ³ /hr	External Wall Motor
FP3ML60S2-IR1140	1140m ³ /hr	In Roof Motor
FP3ML60S2-ER1140	1140m ³ /hr	External Roof Motor
FP3ML60S2-EW1140	1140m ³ /hr	External Wall Motor