

DISHWASHERS

DWA6314W2 SMEG WHITE FREESTANDING DISHWASHER

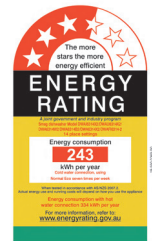
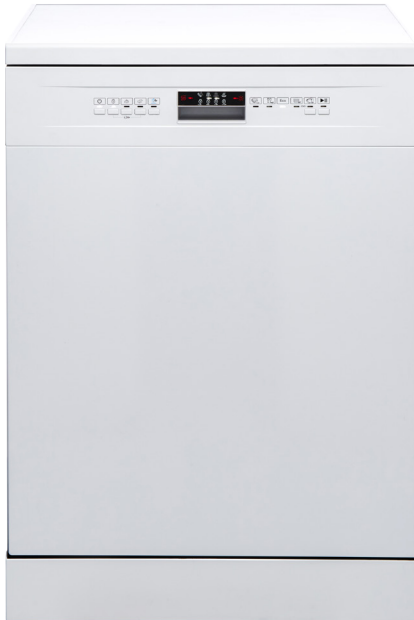

ORBITAL WASH SYSTEM

Smeg's orbital wash system has a major spray arm and satellite spray arm which spins ten times for every single revolution of the major spray arm to ensure water is thoroughly distributed in-between every piece in the wash for exceptional results.

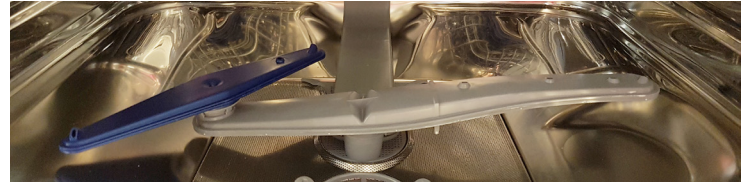

QUICK⁵ WASH OPTIONS

One button automatic adjustment of wash and rinse duration, frequency and temperature to reduce program times by up to 100 minutes across five programs.

CHILD SAFETY LOCK

A must for families with young children, Smeg has developed an electronic system for locking the dishwasher controls. Children can press the buttons without interrupting the wash program. It's also convenient for parents, deactivating with a simple two button combination.

ACTIVE ACQUASTOP

Active Acquastop electronically determines when and how much water to let into the dishwasher, automatically controlling the water feed at the tap. It's a major advantage of a Smeg dishwasher, because there is no water in the hose and therefore no building water pressure, where problems most often occur. Active Acquastop is one of five distinctive water safety and flood prevention features in all Smeg dishwashers.

DELAY TIMER

Every Smeg dishwasher has a delay start option, which allows you to operate the machine during periods of off-peak or lower energy tariffs. The combination of excellent water and energy savings combined with time of use can ensure much lower running costs.

EAN 8017709278830

Size	598mmW x 600mmD x 848mmH
Capacity	14 Place settings
Finish	White
Display	LED lights
Programs	5 + 5 Quick Programs
End of cycle indicator	On display, with acoustic signal
Baskets	3 Levels
Wash system	Orbital Wash System
Water softener	No
Temperatures	38°, 45°, 50°, 65°, 70°C
Features	Fully adjustable upper and middle baskets QuickTime programs Flexizone Flexitabs Self Balancing hinges
Water connection	Hot or cold Water Connection (60°C Max)
Timer	3-6-9-12 hours, with automatic soak
Filtration	Stainless steel 5 stage filter
Drying	Natural condenser drying
Safety	Child safety system (door lock) Active Acquastop
Noise	47dBA
Water usage	9.9 Litres
Power	1800W 220-240V 50 Hz 10A
Warranty	Two years parts and labour

DISHWASHERS

Programs



soak



Normal ECO



Eco



Intensive 65°

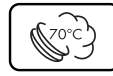

Ultraclean

Quick Programs



Rapid 27



Eco Quick



Daily Quick



Normal Quick



Strong and Fast

Functions

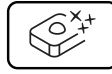

Flexitab

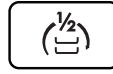

Flexizone



Quicktime



Delay

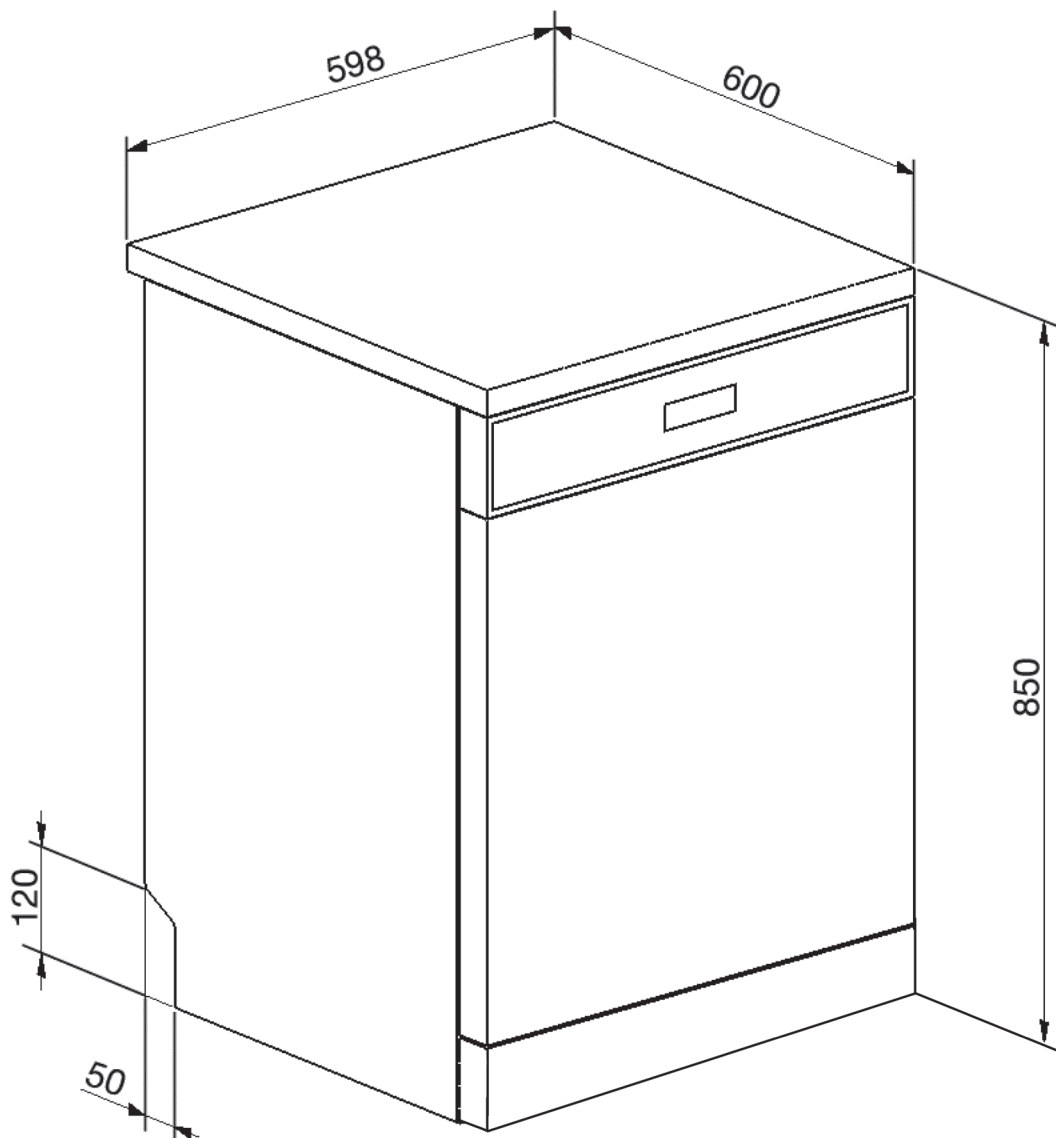

PLEASE NOTE: drawings are not to scale. They are to assist only.
WARNING: technical specifications and product sizes can be varied by the manufacturer without notice.
Cutouts for appliances should only be by physical product measurements. The above information is indicative only.