

TECHNICAL DATASHEET

BOLERO BOX 220-42/29 SBL

Product Category	Sinks
Finish	Stainless Steel
Installation	Inset/Flushmount/Undermount
Range	BOLERO
Model	BOX 220-42/29 SBL
Warranty	50 Years



PRODUCT INFORMATION

Article Number	127.0503.561-FPC
Dimensions	780 x 450mm
Cabinet Base	800mm
Bowl Size	420 x 410 x 200mm/34L 298 x 410 x 200mm/24L
Bowl Radius	12mm
Cut-Out Size	Template
Cut-Out Template	Yes
Waste Outlet	Semi Integrated Waste
Overflow	Yes
Tap Holes	No
Remote Waste	No
Opposite Configuration	-
Accessories	1 2 3 4 5 6

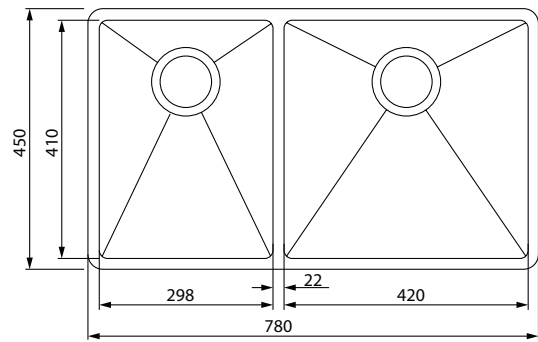

1 ACCESSORIES AVAILABLE **1** ACCESSORIES INCLUDED

ACCESSORIES

- 1**

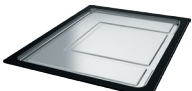

DT 360
Extension Drainer
- 2**



RM 44
Rollamat
- 3**



DB 664
Drainer Basket
- 4**



SB 452
Strainer Bowl
- 5**

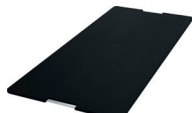



CB 964
Chopping Board
- 6**





CB 931
Chopping Board

FEATURES & BENEFITS

- 

FPC
Food Preparation Centre
- 

18/10
Stainless Steel
- 

Waste to Rear of Main Bowl
- 

Sound Deadening Pads
- 

Franke Bowl Insulation
- 

Flushmount Fit
- 

Fast Fix Installation System
- 

Franke Hidden Overflow

LAST UPDATED: 18 AUG 2016

Make it wonderful

FRANKE