

DWAFI6D15PO

SMEG FULLY-INTEGRATED TALL TANK DISHWASHER PUSH TO OPEN

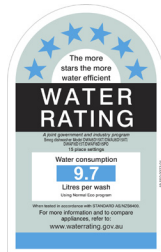

PLANETARY WASH SYSTEM

Smeg has developed many world-first innovations in washing technology and has now launched the world's first dishwasher with planetary wash. The planetary wash system operates with an energy efficient single wash arm which rotates around two axes, significantly increasing the wash pattern density and the cleanliness of the wash. Angled jets also enhance the intensity reaching in between every piece in the dishwasher for the most thorough wash to date.

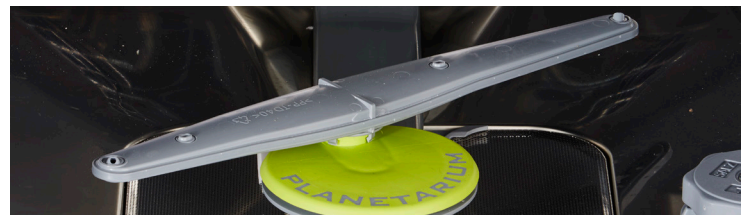

FLEXI-DUO CUTLERY BASKET

The upper cutlery basket folds and slides ingeniously to free space in the basket below for tall items such as stemmed glassware while still providing space in the upper basket for cutlery and utensils.



INTERNAL LIGHT

The clear, bright white LED light provides maximum internal visibility.



SmartDry (Enersave)

Smeg has developed a unique automatic door-opening system, which you can select as an option to open the door slightly at the end of the wash program. The open door allows steam from the wash to escape, reducing condensation and the residual heat of the machine allows the wash to dry naturally and thoroughly, without the consumption of additional energy.



ACTIVE ACQUASTOP

Active Acquastop electronically determines when and how much water to let into the dishwasher, automatically controlling the water feed at the tap. It's a major advantage of a Smeg dishwasher, because there is no water in the hose and therefore no building water pressure, where problems most often occur. Active Acquastop is one of five distinctive water safety and flood prevention features in all Smeg dishwashers.

EAN 8017709220020

Size	598mmW x 547mmD x 858-928mmH max
Capacity	15 Place settings
Finish	Fully-integrated
Display	LED
Programs	5 + 5 Quick Programs
End of cycle indicator	ActiveLight
Baskets	3 Levels
Wash system	Planetary Wash System
Water softener	Yes – electronically adjustable
Temperatures	38°, 45°, 50°, 65°, 70°C
Features	Push To Open door Internal LED lighting Quicktime wash setting for each program ½ Load FlexiZone FlexiTabs Fully adjustable baskets Self Balancing Hinges
Water connection	Hot or cold Water Connection (60°C Max)
Timer	Up to 24 hours, with automatic soak
Filtration	Stainless steel 5 stage filter
Drying	Natural condenser drying with SmartDry (Enersave)
Safety	Active Acquastop
Noise	42dBA
Water usage	9.7 Litres
Power	1800W 220-240V 50/60Hz 10A

DISHWASHERS

Functions



Quicktime

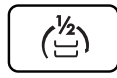

Flexizone



Delay

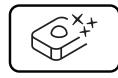

Flexitab



Energysave

Programs



soak



Normal ECO



Eco

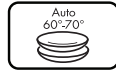

Auto 60-70



Ultraclean

Quick Programs

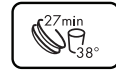

Rapid 27



Normal Quick



Eco Quick



Daily Quick



Strong and Fast

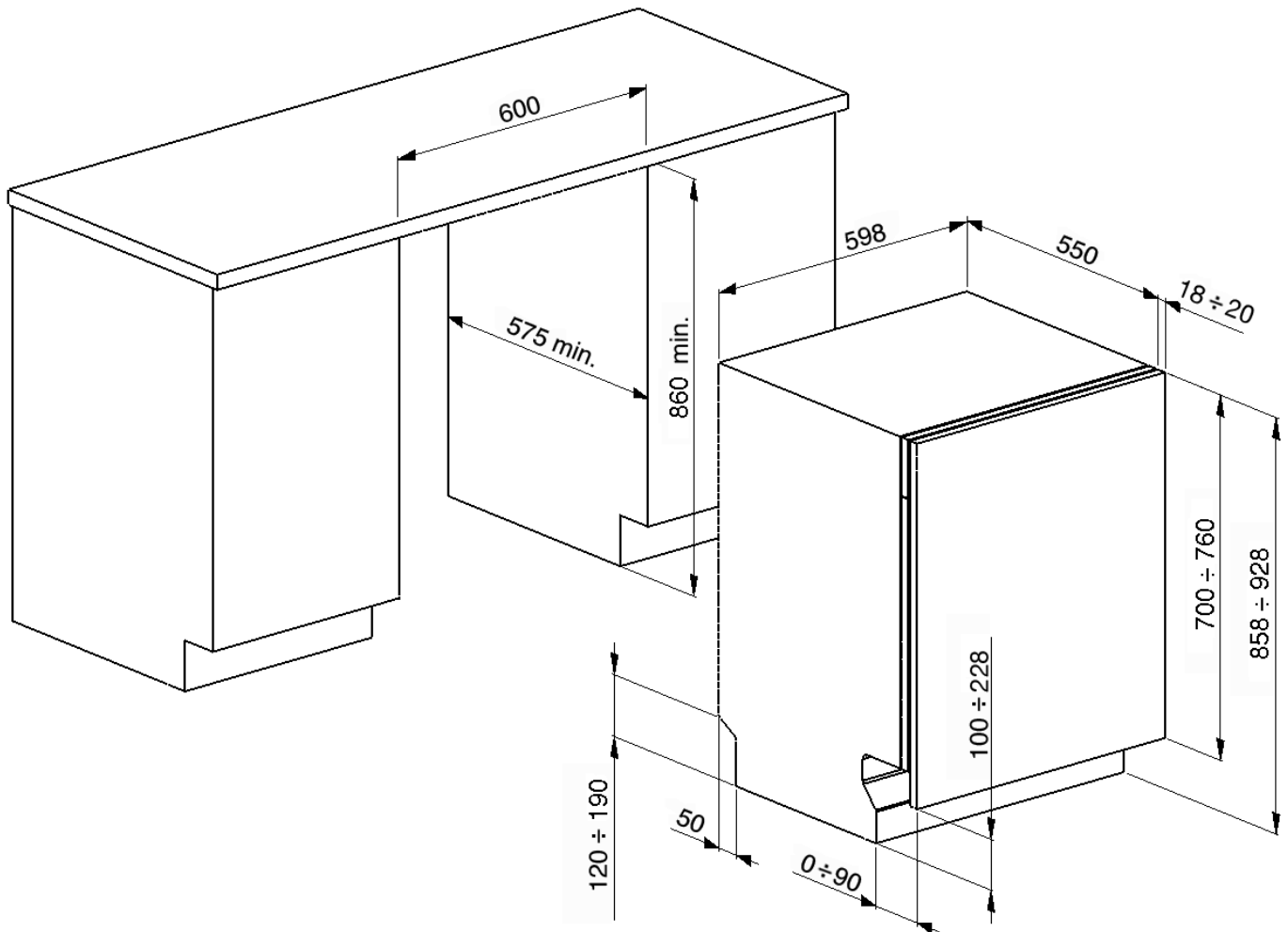

PLEASE NOTE: drawings are not to scale. They are to assist only.
 WARNING: technical specifications and product sizes can be varied by the manufacturer without notice.
 Cutouts for appliances should only be by physical product measurements. The above information is indicative only.