

CREST

*In-wall, wall hung
odourless toilet suite*

Milu
odourless

by expella™

Crest from the Milu Odourless range is an elegantly curved, in-wall toilet with soft modern lines.









The toilet features a patented in-built ventilation system that quietly extracts odours from the toilet bowl and discharges them directly into the sewer before they can be released into the bathroom.

The Milu Odourless range is manufactured in high quality vitreous china and incorporates rimless flush technology, making the toilets easy to clean and maintain.

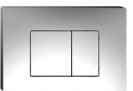

PRODUCT SPECIFICATIONS

Recommended use	Domestic, hotel, commercial
Water rating	WELS 4 Star at 4.5L flush and 3L flush. LIC. 1848
Compliance	Complies with Australian Standards - AS1172.1, AS1172.2, ATSS200.425.425:2009
Fixing	Toilet pan screwed through wall to frame. Fixings included.
Rim configuration	Rimless
Trap configuration	Universal (S Trap included)
Material	Vitreous china
Seat	Soft close, quick release
Water inlet	Top left
Power supply	12 volt, 1.5amp (transformer provided).
Fan	Expella OCD

Flush plate options	 Round black	 Round chrome	 Round white
	 Soft black	 Soft chrome	 Soft white
	 Square black	 Square chrome	 Square white

CREST

In-wall, wall hung
odourless toilet suite

DIMENSIONS AND SET-OUT (all measurement specified in millimetres)

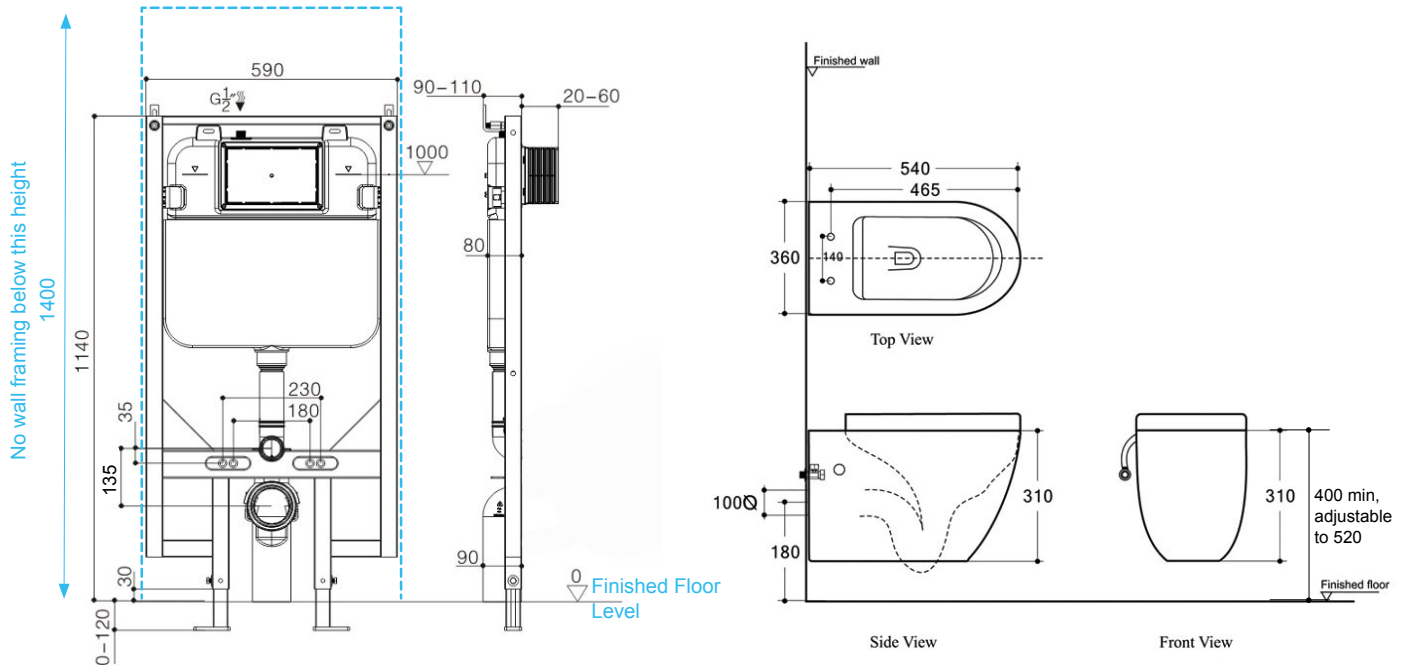

HOW IT WORKS

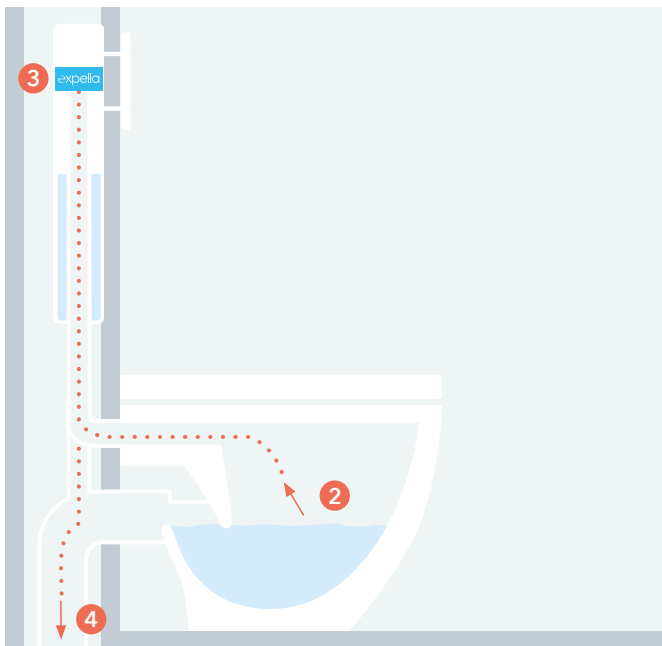

- 1 Expella's patented Odour Control Device (OCD) is hidden inside the cistern, it is activated by either a:
 - Light switch*
 - Manual switch*
 - Automatic sensor switch.*
- 2 The OCD contains an in-built extraction fan that draws odours from the bowl through the flush pipe.
- 3 Odours pass through the OCD, opening a non return valve that prevents odours returning.
- 4 Odours are discharged to the sewer.

* Switching not included

WaterMark
WMKA 23157

Patent: AU2007204583, AU2018000006

Milu
odourless
by expella™