



# HYDROTAP G5 B ARC CHROME



BOILING

FILTERED

## Order Code H52786Z00AU

Zip HydroTap Design Range Boiling, Filtered water system features a single under bench command centre including full colour interactive touch screen display with pin code protection and customisable settings including boiling water safety mode, 3 energy saving modes including ON/OFF timers and 2 hour sleep mode, SteriTouch® antimicrobial protection impregnated into key water paths for enhanced hygiene, and 0.2 micron water filtration.

Manufacturing Code H52786Z00AU

Capacity Residential



Tap	Zip HydroTap Design Range ARC Tap (Chrome)
Water Pressure	Min 170kPa - Max 700kPa
Water Connection	1/2" BSP (G1/2)
Water Supply Requirements	Cold
Water Valves	Integrated 500kPa Pressure limiting valve and Dual Check Valve
Power Rating	1.35kW 220-240V 50Hz
Power Supply	1 x 10 Amp socket outlet
Dimensions	W280mm x D313mm x H333mm
Product Approvals	WaterMark, RCM
Warranty	5 years (appliance warranty 36 months plus additional 24 months tank warranty)

## Installation Requirements

'1. Installation and connection of your Zip HydroTap must be carried out by a qualified person, observing national and local regulations.2. You will require suitable mains electrical and drinking water connections, plus waste water drainage all within 1.5 metres of the product.3. HydroTap is air-cooled so discrete cabinetry cut-outs are required for ventilation.4. Installation on most bench tops is straightforward however some stone bench tops may require a specialised cutting service.5. If you live in a hard water area, we recommend installation of a Zip scale filtration kit.6. Installation by Zip Professional Service can be arranged with a phone call or through [www.zipwater.com](http://www.zipwater.com)'

### Installation Detail



**Ventilation requirements** Contact your local service provider if ventilation is not suitable

**Clearance envelope**

Position the Tap and the Command Centre as close together as possible.

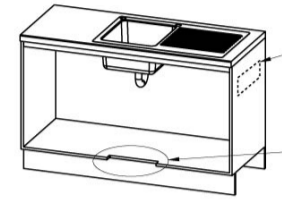
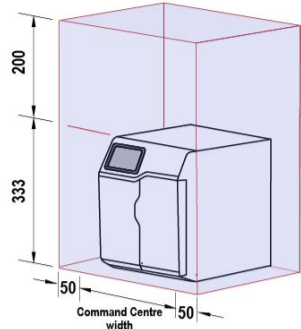

Air outlet louvre (if required)  
Cut-out in door/wall, towards the top of the cabinet



Air inlet cut-out (required)  
Cut-out in cabinet floor

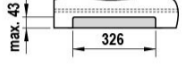

**HydroTap Tap options**

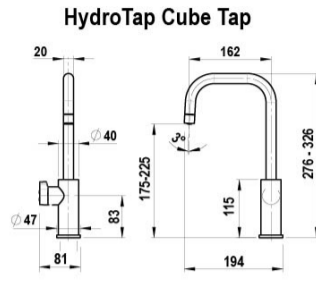
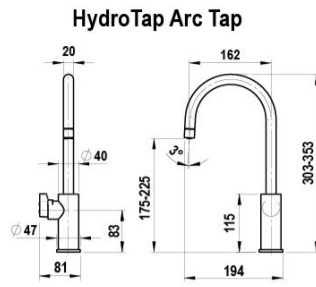

**Standalone Font with Arc Tap**

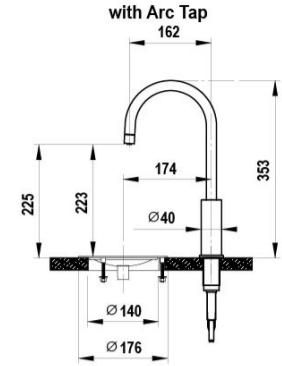

**Cutting detail**

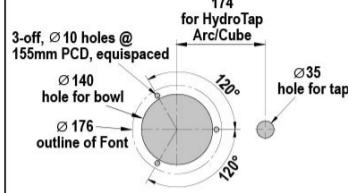

**Tap Positioning**

Position the Tap to dispense into the sink, allowing clearance for a cup or teapot. Alternatively, mount on a Font (available as an accessory).

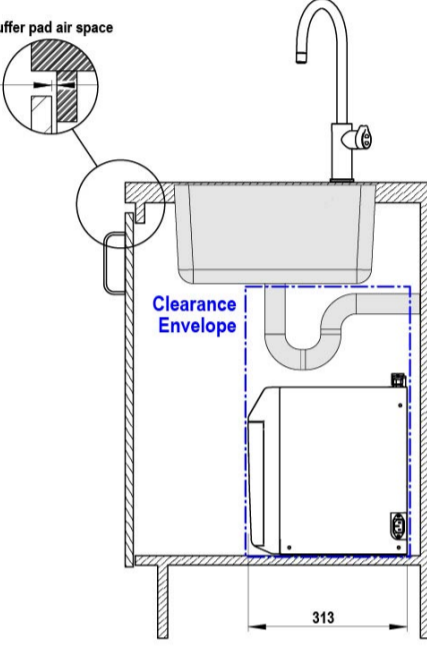
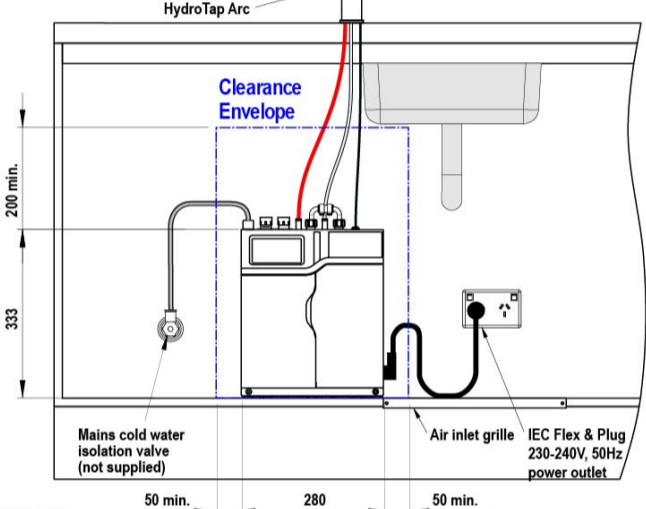
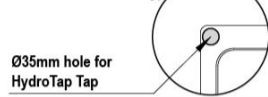

SCALE 1:5  
ALL DIMENSIONS IN MM UNLESS OTHERWISE SPECIFIED. INSTALLATION DIAGRAMS ARE FOR ILLUSTRATIVE PURPOSES ONLY. HOSES ARE NOT SHOWN TO SCALE AND CANNOT BE LENGTHENED.

**HydroTap G5**  
B Home, B60, B100  
BA Home, BA60, BA100  
shown with HydroTap Arc

