

HWF85AN1

Front Loader Washing Machine, 8.5kg

This front loader not only has 4.5 star water and 4 star energy ratings, it includes specialised functions such as Sanitise, Refresh and a super-fast Express 15 cycle. +Garment adds everyday convenience, with forgotten items able to be added after the wash cycle has started.



Haier

Height

850 mm

Width

595 mm

Depth

610 mm

Weight

70 kg

FEATURES

- Sanitise is a high-temperature solution, killing bacteria for more hygienic washing.
- The short Refresh cycle uses steam technology to refresh folded and stored clothes.
- The Speed up function effectively reduces the time of most wash cycles, and is perfect for lightly-soiled clothes.
- A super-fast Express 15 cycle is perfect for busy lives and lightly soiled clothes.
- The convenient +Garment lets you add in any forgotten items, even when the wash has already started.
- Anti-Bacteria Treatment (ABT) in the gasket and laundry detergent dispenser helps keep your laundry environment hygienic.
- WiFi-enabled for future compatibility with remote access and smart home appliances.

ACCESSORY

- Hose set provided
- Noise reduction pads
- User manual

ELECTRICAL

- Supply 220V-240V, 50Hz
- Service 10-amp circuit
- Connection 3-prong grounding-type

PLUMBING PRESSURE

- Max. 1MPa (150psi) Min. 30KPa (4.5psi), Min. 6 litres/min

Product overview

PRODUCT DIMENSIONS

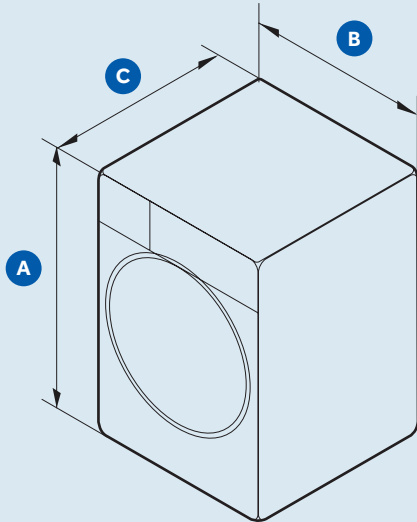

		mm
A	Overall height	850
B	Overall width	595
C	Overall depth	610
D	Depth with door opened	1084
E	Min. Door Clearance to adj. wall	260

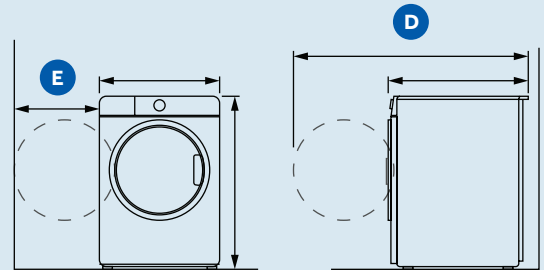

CAVITY DIMENSIONS

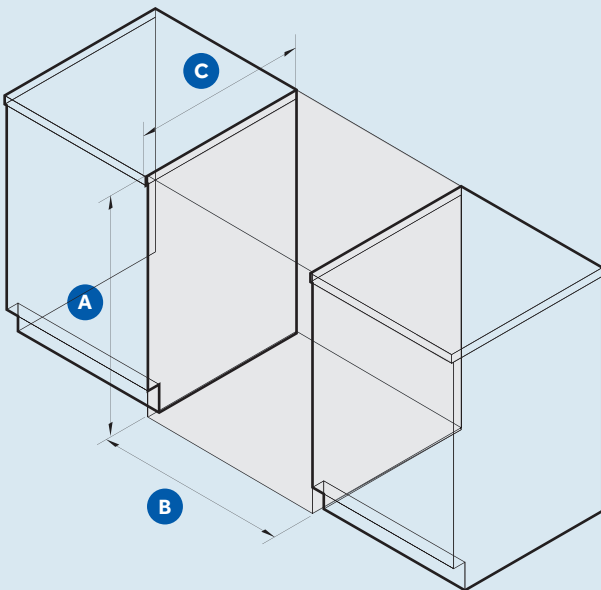

		mm
A	Overall height	870
B	Overall width	635
C	Min. overall cav flush with front panel	550
	Min. gap clearance to adj. product or wall	20