

Kaali 60

UB-KAA-60-IO



Undermount Basin

- Made from QUARRYCAST™
 - One piece casting of Volcanic Limestone™ and resin
 - Harder & more durable than acrylic
- Easy clean high gloss finish
- Integrated internal overflow
- 25 year guarantee

Einbau-Waschbecken

- Hergestellt aus QUARRYCAST™
 - Ein Gussteil aus seltenem vulkanischen Kalkstein und Harz
 - Härter und haltbarer als Acryl
- Leicht zu reinigende glänzende Oberfläche
- Integrierter Überlauf
- 25 Jahre Garantie

Vasque à encastrer par dessous

- Fabriquée en QUARRYCAST™
 - Ensemble d'une pièce en pierre volcanique rare et résine
 - Matériau plus dur et plus résistant que l'acrylique
- Fini ultra brillant, facile à nettoyer
- Trou de trop-plein intégré
- Garantie de 25 ans

Lavabo de montaje bajo encimera

- Hecho de QUARRYCAST™
 - Hecho en una pieza de piedra volcánica y resina
 - Más resistente y duradero que acrílico
- Fácil de limpiar y acabado brillante
- Dispositivo interno integrado para protección ante desbordamientos
- 25 años de garantía

Lavabo per sottopiano

- Costituito da QUARRYCAST™
 - Un unico pezzo di rara roccia calcarea vulcanica e resina
 - Più robusto e resistente dell'acrilico
- Intensa finitura lucida facile da pulire
- Troppopieno interno integrato
- 25 anni di garanzia

25
years

Guaranteed for residential use for 25 years*
 25 Jahre Garantie bei privater Nutzung
 25 ans de garantie pour un usage domestique
 Garantía de 25 años para uso domestico
 La sicurezza garantita per uso residenziale per 25 anni

8
years

Guaranteed for commercial use for 8 years*
 8 Jahre Garantie bei gewerblicher Nutzung
 8 ans de garantie pour un usage commercial
 Garantía de 8 años para uso comercial
 La sicurezza garantita per uso commerciale per 8 anni

Kaali 60

UB-KAA-60-IO

Special Options/Sonderoptionen/Options spéciales/Opciones especiales/Opzioni speciali

Recommended: K24/K25



Internal overflow
Trop-plein interne
Rebosadero integrado



K24



K25



Undermount

Kaali 60

UB-KAA-60-IO

Top view

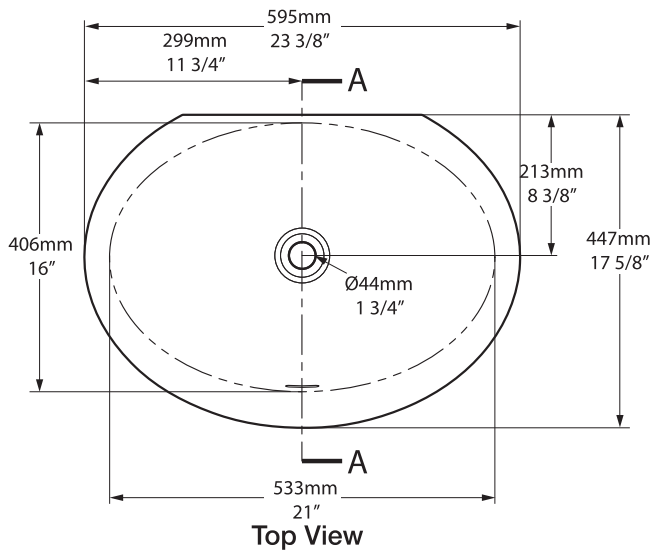

Side view

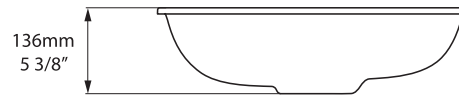

Front view



Section AA

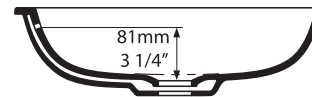

*All measurements subject to +/-5% tolerance

